

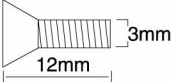













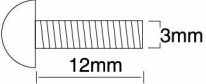





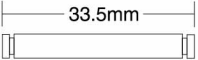



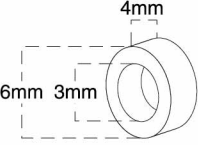

Abbreviations

	CCS	Countersunk Cap Screw	
	CS	Cap Screw	
	FCS	Flathead Cap Screw	
	BCS	Buttonhead Cap Screw	
	CM	Countersunk Machine Screw	
	RM	Roundhead Machine Screw	
	WM	Washerhead Machine Screw	
	SS	Shoulder Screw	
	CST	Countersunk Self-tapping Screw	
	RST	Roundhead Self-tapping Screw	
	WST	Washerhead Self-tapping Screw	
	FN	Flange Nut	
	NL	Nylon Locknut	
	PB	Plastic Bushing	
	GS	Set (Grub) Screw	
	PW	Plastic Washer	
	AS	Aluminum Spacer	
	PTW	PTFE Washer	
	MW	Metal Washer	
	E	E-Clip	
	SW	Split Washer	
	BB	Ball Bearing	
	SLB	Self-lubricating Bushing	
	NRB	Needle Roller Bearing	
	ELW	External Lock Washer	

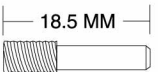

TRAXXAS EREVO™

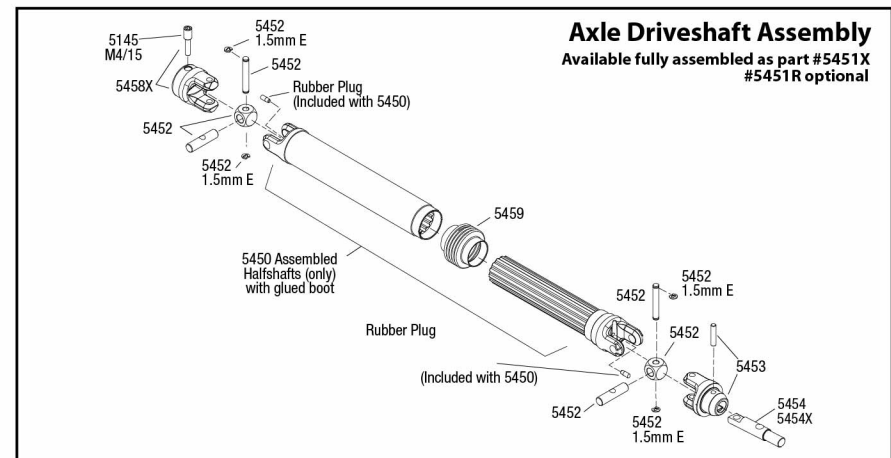
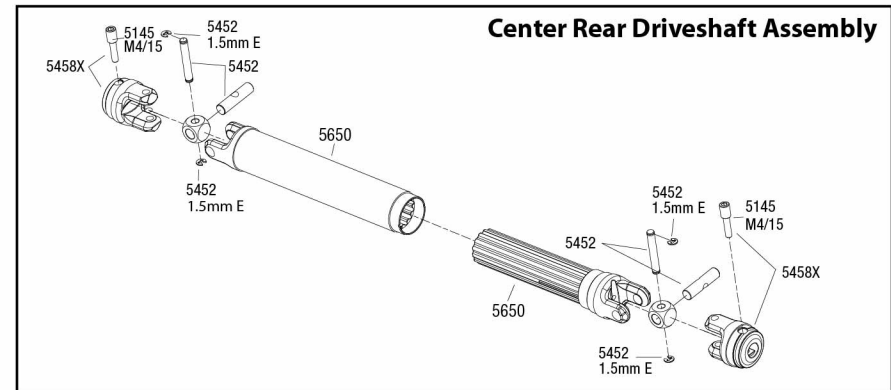
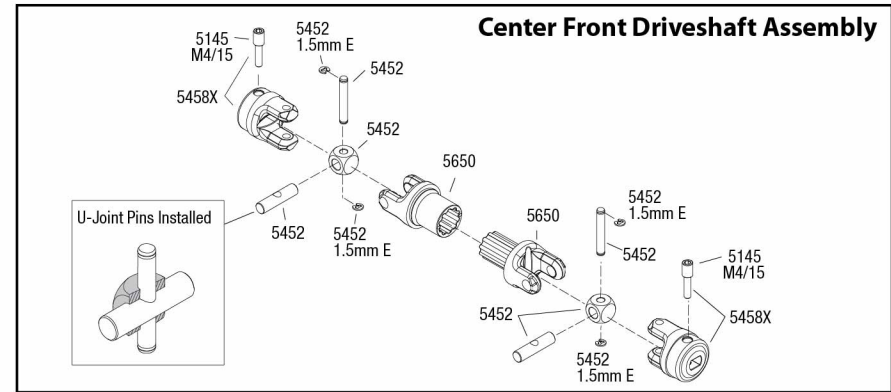
Front Assembly

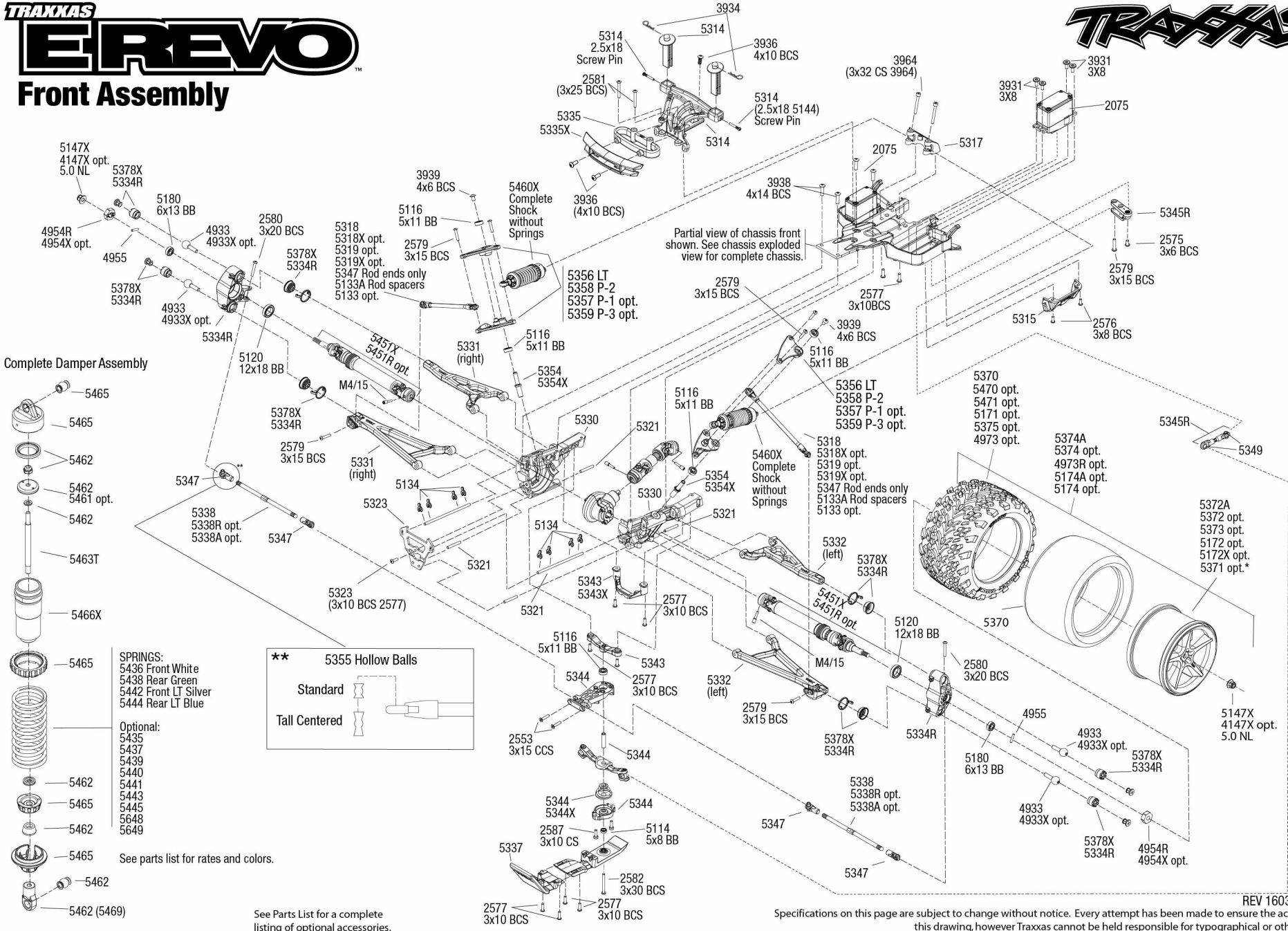

Specifications on this page are subject to change without notice. Every attempt has been made to ensure the accuracy of this drawing, however Traxxas cannot be held responsible for typographical or other errors.

TRAXXAS
EREVO
Transmission Assembly

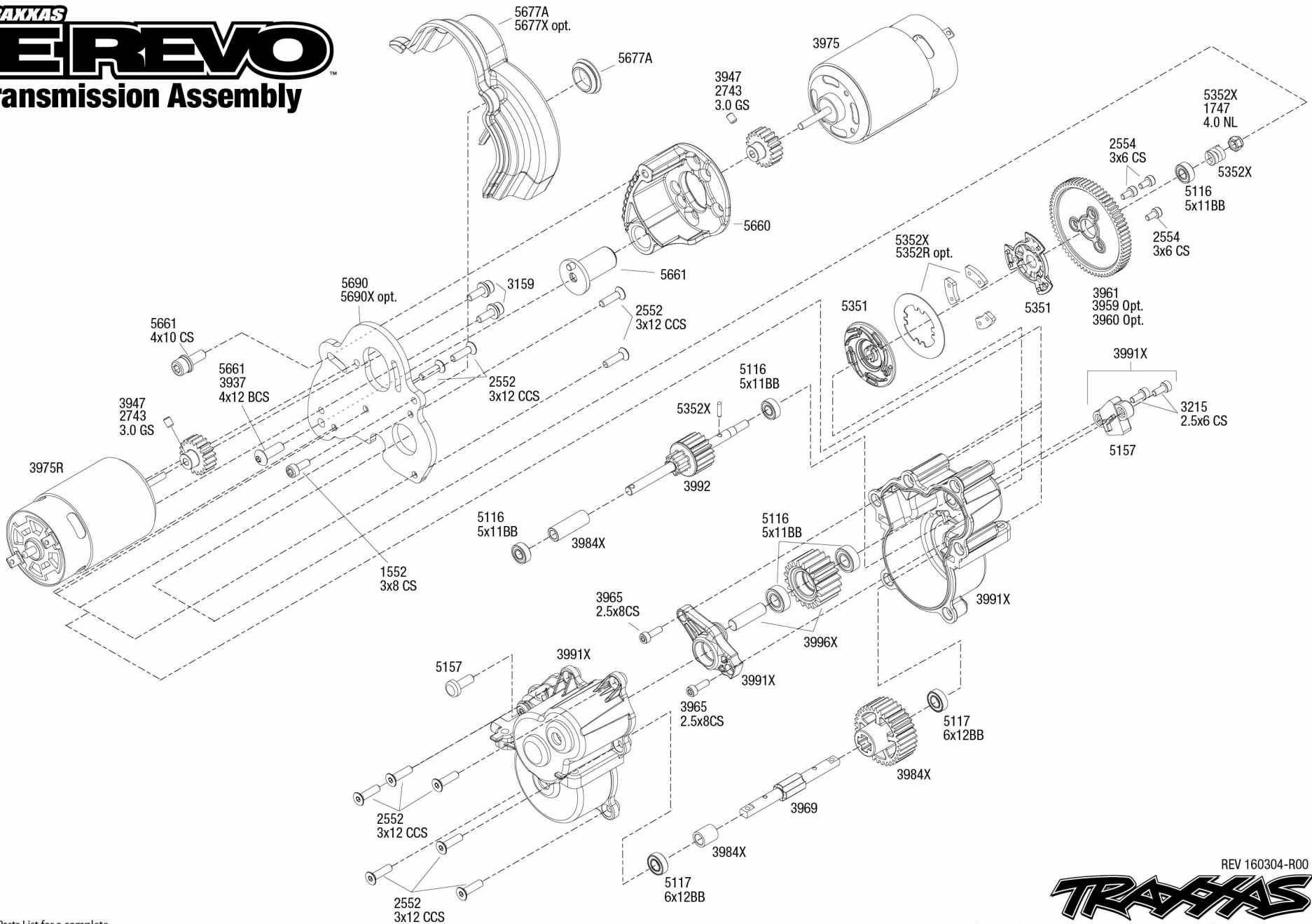

See Parts List for a complete listing of optional accessories.

REV 160304-R00
TRAXXAS
 Specifications on this page are subject to change without notice. Every attempt has been made to ensure the accuracy of this drawing, however Traxxas cannot be held responsible for typographical or other errors.